

BOM LIST			
ITEM	PART NAME	Q'ty	NOTES
1	PLASTIC HOOD	2	ABS
2	BOLT	2	#4-40
3	NUT	2	M3
4	LONG SCREW	2	M3
5	SMALL WASHER	2	
6	SHORT SCREW	2	M3
7	MIDDLE WASHER	2	M3

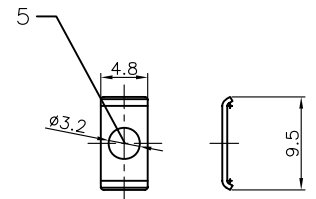

REV.	DESCRIPTION	DRAWN	CHECKED	APPROVED

NOTES:
1. PART NUMBER CODE:
DS1046 - 09 X X X

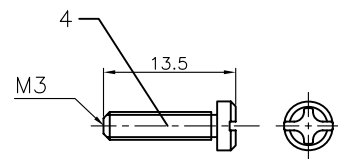
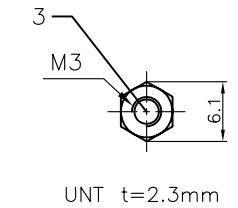
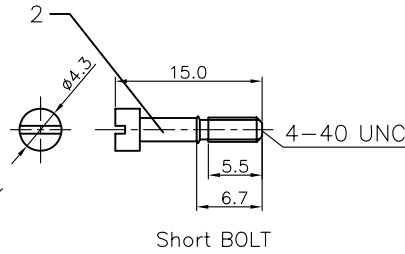
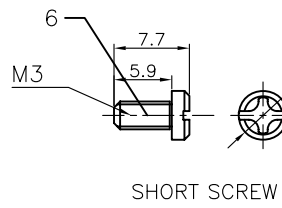
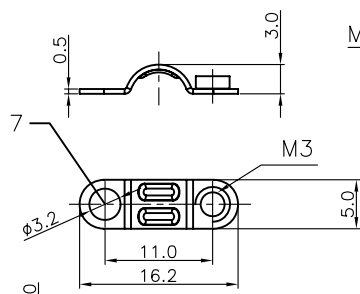
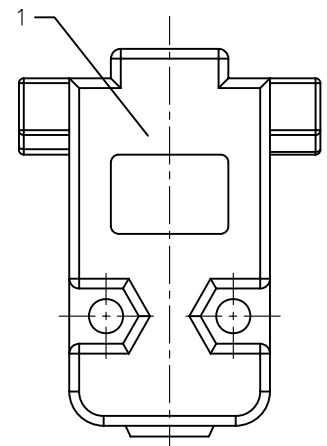
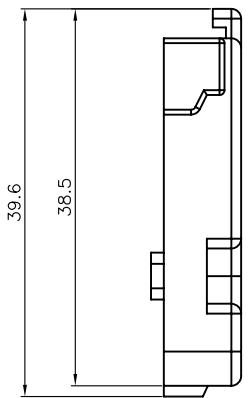
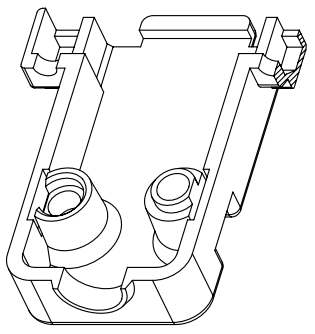

Bolt type
L: Long
S: Short

Packing type
1: Mix packing
2: Separation packing

Cover Material
C: Chromium Plated

Positions
09: 9pin

GENERAL TOLERANCE		ANGLE TOLERANCE		PROJECTION	TITLE
X.	±0.60	X.	±5°	mm	D-SUB 9pin Cover Chromium Plated
.X	±0.38	.X	±3°	A4	SERIES DS1046 SERIES
.XX	±0.25	.XX	±2°	DN-9C	
DRAWING TYPE		COSTOMER			
SCALE		1:1	SHEET	1 OF 1	
DRAWING NO.		C-DS1046-09XXX			